

ecocemento

r-evolution

GRANITOKER



CASALGRANDE
PADANA
THE GREEN WAY TO PAVE



PLAY VIDEO

r-evolution

GRANITOKER



FLOOR: r-evolution azure cm 60x60 - 23^{5/8}"x23^{5/8}"

COLORI COLOURS COULEURS FARBEN

r-evolution black

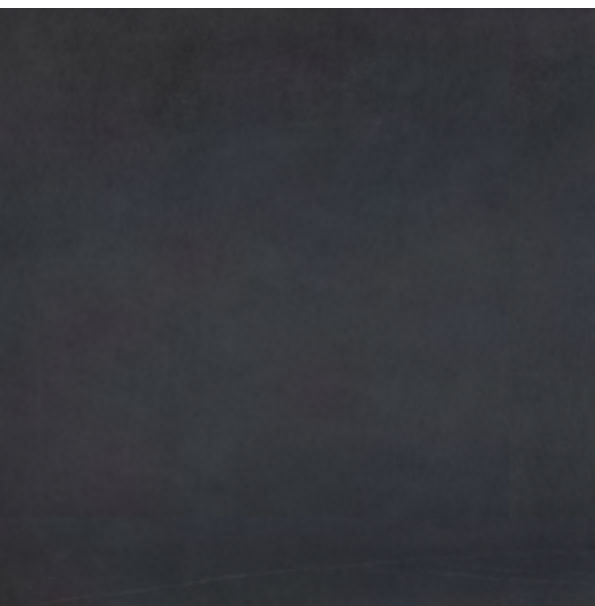

r-evolution dark grey



r-evolution blue



r-evolution terra



r-evolution tortora



r-evolution sand

r-evolution

GRANITOKER

r-evolution azure



r-evolution green



r-evolution light pink

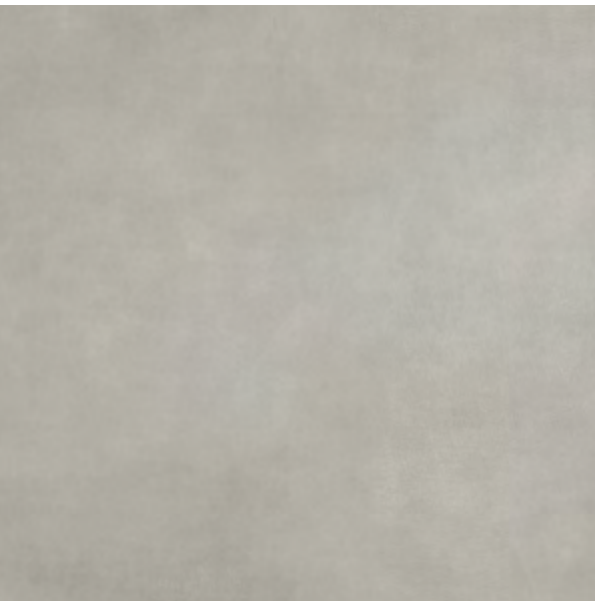

r-evolution grey

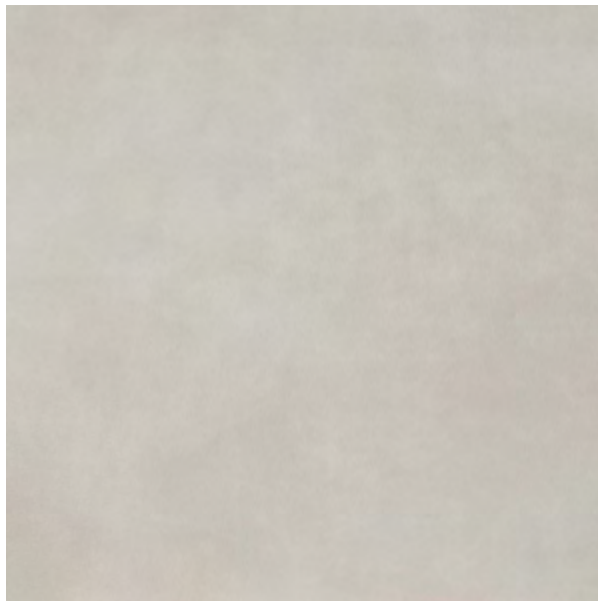

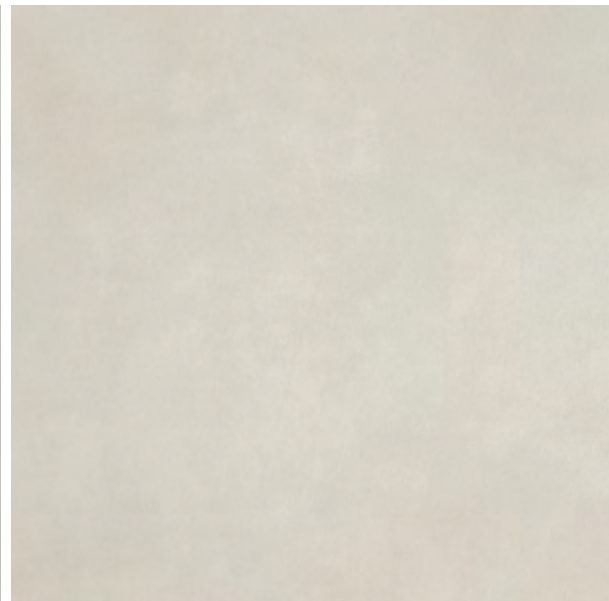

r-evolution white



r-evolution total white

FORMATI SIZES FORMATS FORMATE

| | | | |
|---|---|---|---|
| |  |  |  |
| Formati Sizes Formats Formate | cm 30x60 11 ^{3/4} "x23 ^{5/8} " | cm 60x60 23 ^{5/8} "x23 ^{5/8} " | cm 60x120 23 ^{5/8} "x47 ^{1/4} " |
| Spessori Thicknesses Epaisseurs Stärken | mm 9 | mm 9 | mm 9 |
| Superfici Surfaces Surfaces Oberflächen | ● ● | ● ● | ● ● |



Leggera
Minimal
Légère
Leichte

● Naturale Matt Naturelle Matt
● Naturale Matt Naturelle Matt **R10 A+B PTV>36**

Vedi pagina: See page: Voir page : Siehe Seite: **490**

Rettificate in un unico calibro Rectified version in a single caliber Rectifiés en un unique calibre Boden Sie in einem einzigen Kaliber

Consigliata per residenziale e commerciale leggero Suitable for residential or light commercial

Conseillé pour résidentielle et commerciale à circulation légère Geeignet für wohn oder leichte kommerzielle

Caratteristiche tecniche ed estetiche a pagina: Technical and aesthetics features on page:

Caractéristiques techniques et esthétiques à la page : Technische und ästhetische Eigenschaften auf Seite: **481**

PEZZI SPECIALI TRIMS ACCESSOIRES FORMSTÜCKE

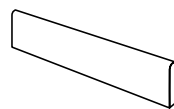

Battiscopa
Bullnose
Plinthe à bord arrondi
Stehsockel

cm 7x60
2^{3/4}"x23^{5/8}"

Formati Sizes
Formats Formate

cm 7x90
2^{3/4}"x35^{3/8}"

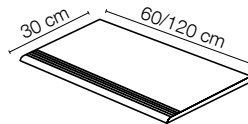

Gradino
Step tread
Nez de marche
Stufenplatte

cm 30x60
11^{3/4}"x23^{5/8}"

cm 30x120
11^{3/4}"x47^{1/4}"

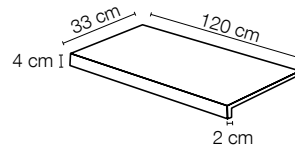

Gradone
(assemblato)

cm 120x33
47^{1/4}"x13"

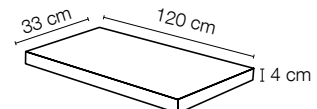

Angolare
(assemblato)

cm 120x33
47^{1/4}"x13"

r-evolution

GRANITOKER

DECORI DECORS DÉCORS DEKORE

mosaico 6x6 ■

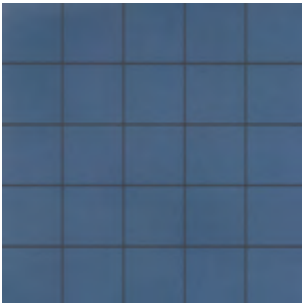

cm 30x30 - 11^{3/4}"x11^{3/4}"
 tessera cm 6x6 - 2^{3/8}"x2^{3/8}"
 su rete on net sur trame auf Netz

stripes**



cm 60x120 - 23^{5/8}"x47^{1/4}"

■ Disponibile in tutti i colori della serie Available in all the colours of the series
 Disponible dans toutes les couleurs de la série Verfügbar in allen Farben

** Solo per posa affiancata Only for side-by-side installation
 Uniquement pour une installation côte à côte Nur fuer die Installierung nebeneinander geeignet

Disponibile nei colori: Available in the colours:
 Disponible dans les couleurs : Verfügbar in den folgenden Farben:
A (Total White/Black), **B** (White/Grey), **C** (Sand/Tortora), **D** (Total White/Blue)



WALL: r-evolution blue cm 60x120 - 23^{5/8}"x47^{1/4}", stripes cm 60x120 - 23^{5/8}"x47^{1/4}"
 FLOOR: r-evolution blue cm 60x120 - 23^{5/8}"x47^{1/4}", mosaico blue cm 30x30 - 11^{3/4}"x11^{3/4}"

R-EVOLUTION

GRANITOKER

Gres porcellanato Fully vitrified porcelain

Grès cérame vitrifié Feinsteinzeug

CARATTERISTICHE TECNICHE TECHNICAL FEATURES

CARACTÉRISTIQUES TECHNIQUES TECHNISCHE EIGENSCHAFTEN













CASALGRANDE
PADANA

THE GREEN WAY TO PAVE



UPEC**



| | norma standards norme Norm | risultato prova* test results* resultats des essais* Ergebnisse* |
|---|---|---|
|  classificazione prodotto product classification classement Klassifizierung | UNI EN 14411-G ISO 13006 | gruppo Bla completamente greificato group Bla fully vitrified group Bla grès cérame fin Gruppe Bla Feinsteinzeug |
|  caratteristiche dimensionali e d'aspetto dimensional and surface quality caractéristiques de la surface Oberflächenqualität | UNI EN ISO 10545-2 | tolleranze minime nella 1ª scelta very low tolerance des tolérances minimales en 1er choix Entspricht Normen |
|  assorbimento di acqua water absorption absorption d'eau Wasseraufnahme | UNI EN ISO 10545-3 | < 0,1% |
|  resistenza alla flessione flexural strength résistance à la flexion Biegezugfestigkeit | UNI EN ISO 10545-4 | 45 N/mm ² |
|  resistenza al gelo frost resistance résistance au gel Frostwiderstandsfähigkeit | qualsiasi norma all standards toute norme alle normen | garantita guaranteed garantie Garantiert |
|  resistenza attacco chimico (esclusione acido fluoridrico) resistance to acids and alkalis (with the exception of hydrofluoric acid) résistance à l'attaque chimique (exclusion de l'acide fluorhydrique) Säure und Laugen Beständigkeit (mit Ausnahme von Fluorwasserstoff) | UNI EN ISO 10545-13 | A |
|  resistenza usura e abrasione wear and abrasion resistance résistance à l'usure et abrasion Abriebhärte | UNI EN ISO 10545-6 | ≤ 150 mm ³ |
|  dilatazione termica lineare linear thermal expansion coefficient linéaire de dilatation thermique Lineare Wärmeausdehnung | UNI EN ISO 10545-8 | 6 x 10 ⁻⁶ |
|  resistenza alle macchie stain resistance résistance aux taches Fleckenfestigkeit | UNI EN ISO 10545-14 | 4 - 5 garantita guaranteed garantie Garantiert |
|  resistenza alla scivolosità (Superficie Naturale) slip resistance (Matt surface) résistance au glissement (Surface naturelle) Trittsicherheit (Natur Oberflächen) | DIN EN 16165 ANNEX B / ANNEX A D.M. N° 236 DEL 14.06.89 METODO B.C.R. DIN EN 16165 ANNEX C | Naturale R10 A+B PTV>36 valore μ > 0,40 PTV > 36*** |
|  resistenza dei colori alla luce colour resistance to sunlight exposure résistance de la couleur à la lumière Unveränderlichkeit der Farben wenn Strahlung zugesetzt wird | DIN 51094 | nessuna variazione no change of colours couleurs inchangées Keinerlei Farbänderung |

* valore indicativo approx value donnée approximative Ungefähre Werte

** si rimanda all'elenco prodotti UPEC ufficiale, consultabile sul sito: please see the official UPEC product list:

veuillez consulter la liste officielle produits UPEC: sihe die offizielle UPEC-Produktliste auf der Website: <http://evaluation.cstb.fr>

*** prova su superficie asciutta test on a dry surface essai sur surface sèche Test auf trockener Oberfläche

Al pari dei materiali naturali di riferimento, l'aspetto estetico, la differenza di tono e le venature possono essere diverse da piastrella a piastrella. Per una corretta comprensione della variabilità del prodotto è consigliabile prendere visione delle immagini a tutto ambiente sul catalogo di collezione, sul nostro sito all'indirizzo www.casalgrandepadana.it o chiedere maggiori informazioni ai nostri concessionari.

Just like the natural materials they are inspired by, the aesthetics, colouration and veining of the tiles can differ. To properly gauge the suitability of a product, we advise that you view the full-space photos that you can find in our collection catalogue and on our website at www.casalgrandepadana.com. Alternatively, please ask a reseller for more information.

Tout comme pour les matières naturelles de référence, la différence de tonalité, les veines ainsi que l'aspect esthétique peuvent varier d'une dalle à l'autre. Pour bien comprendre la variabilité du produit, il est conseillé de consulter les images d'ambiance présentes sur le catalogue de la collection, sur notre site à l'adresse www.casalgrandepadana.fr ou de demander plus d'informations à nos concessionnaires.

Wie bei den als Vorbild dienenden Naturmaterialien können sich auch hier das ästhetische Erscheinungsbild, der Farbtonunterschied und die Maserung von Fliese zu Fliese unterscheiden. Um die Variabilität des Produkts besser zu verstehen, raten wir Ihnen, die Bilder mit ausgestatteten Räumen im Kollektionskatalog auf unserer Website www.casalgrandepadana.de zu konsultieren. Weitere Informationen können Sie auch bei unseren Vertragshändlern erhalten.



CASALGRANDE
PADANA
THE GREEN WAY TO PAVE

via Statale 467, n. 73 - 42013 Casalgrande (Re) Italy
tel + 39 0522 9901 - fax + 39 0522 996121
info@casalgrandepadana.it - www.casalgrandepadana.com

